

# Panasonic®

Advanced Hybrid System

## User Guide for KX-TD7896

---

Model KX-TA308/KX-TA624/KX-TA824



**Thank you for purchasing the Panasonic KX-TD7896 Wireless PT (Wireless Proprietary Telephone). Please read this manual carefully before using this product and save this manual for future use.**

This manual is designed to be used with the KX-TD7896 Wireless PT (Wireless Proprietary Telephone) and a Panasonic KX-TA series (other than KX-TA1232) PBX (Business Telephone System).

**Please use only the battery provided and charge the battery for about 7 hours before using the handset for the first time.**

# Table of Contents

---

<b>Location of Controls .....</b>	<b>3</b>
<b>Before Operating the Handset .....</b>	<b>5</b>
Unsupported PBX Features .....	5
Selecting the Display Language .....	5
Setting the Date and Time .....	6
Enabling the Outgoing Call Log .....	6
Entering the Standby Display Name .....	7
Entering the Names of the Flexible Keys .....	7
Adjusting the Ringer Volume .....	8
Adjusting the Vibrate Setting.....	9
Adjusting the Receiver/Speaker/Headset Volume .....	9
<b>Handset Display .....</b>	<b>10</b>
Icons .....	10
Soft Keys.....	11
Operation Outline .....	12
<b>Operation for the KX-TA308/624/824 .....</b>	<b>16</b>
Making Calls .....	16
Receiving Calls .....	18
When the Dialed Extension is Busy/No Answer.....	19
During a Conversation .....	20
Useful Features.....	20
Making Use of the Voice Mail Service.....	22
<b>Using the Handset Phonebook .....</b>	<b>23</b>
Handset Phonebook .....	23
Storing an Item in the Handset Phonebook .....	23
Entering Characters .....	25
Locking the Handset Phonebook .....	27
<b>Deleting Stored Items .....</b>	<b>28</b>
Deleting Stored Items in Handset Phonebook/Hot Key Dial/Incoming Call Log/ Outgoing Call Log .....	28
<b>Setting the Handset and Base Unit .....</b>	<b>29</b>
Setting the Handset and Base Unit.....	29
<b>Troubleshooting and Error Messages .....</b>	<b>35</b>
Troubleshooting .....	35
Error Messages.....	37
<b>Important Information.....</b>	<b>38</b>
Battery Information.....	38

# Location of Controls

## ◆ Handset

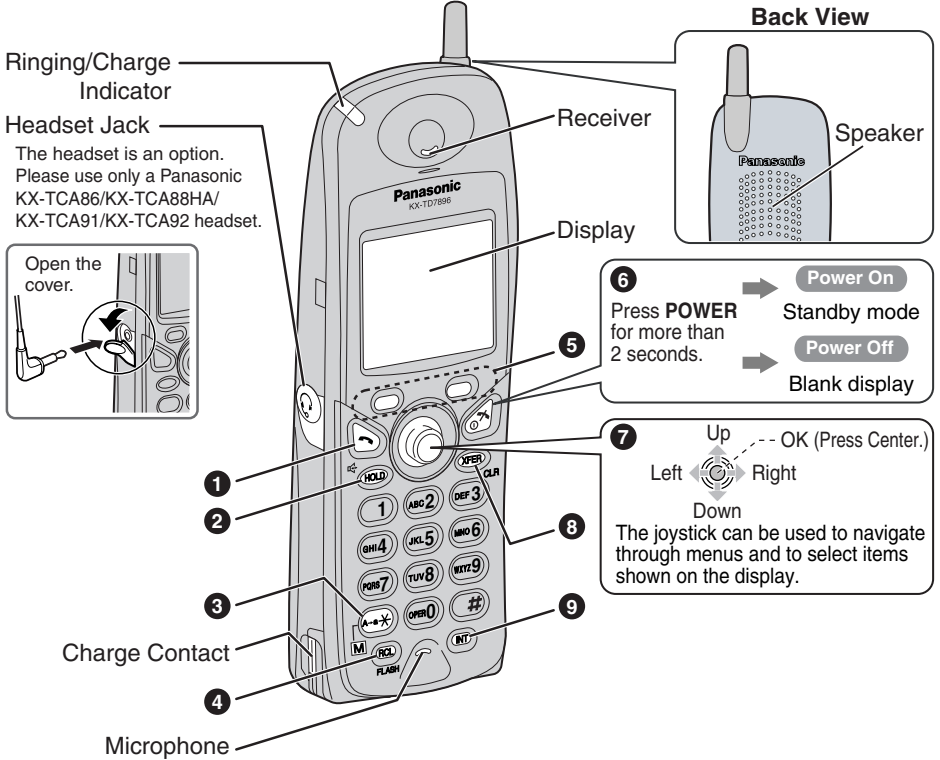

# Location of Controls

**1 TALK/SP-PHONE (Speakerphone) Key:**  
Used to make or answer calls, or toggle between the two conversation modes (Receiver/Hands-free\*) during a conversation.

\* You can talk with the other party alternately through the speaker without holding the handset.

**2 HOLD Key:**  
Used to place a call on Hold.

**3 Meeting Mode Key:**  
Used to turn Meeting Mode on or off when pressed for more than two seconds in standby mode.

**4 RECALL/FLASH Key:**  
Used to disconnect the current call and make another call without hanging up, or answer a Call Waiting from the telephone company.

**5 Left/Right Soft Key:**  
Used to select the function displayed directly above each key. Functions displayed depend on the state of use.

**6 POWER/CANCEL Key:**  
Used to end calls, exit the Phonebook or Function mode, or turn the handset on or off.

**7 Joystick:**  
Used to adjust the ringer/receiver volume, select the Function mode and the function displayed directly above it, and move the cursor to select a desired item.

**8 TRANSFER/CLEAR Key:**  
Used to transfer a call to another party, or clear digits or characters.

**9 INTERCOM Key:**  
Used to make or answer intercom calls.

**◆ Key Lock**  
You can lock all keys other than the Joystick while the handset is in standby mode.

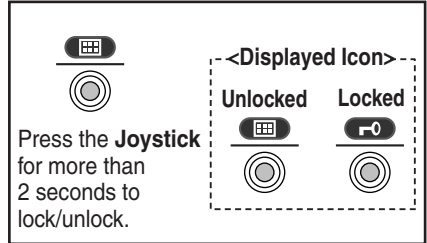

**◆ Meeting Mode**  
You can set the handset to prevent incoming calls from ringing. This can be useful in situations where you do not want to be disturbed, for example during a meeting.

• During Meeting Mode, functions are:

Function	Status
Microphone volume	Up
Low battery alarm	Off
Key tone	Off
Ringer/Voice Call/Paging/LCS	Off
Ring On Charger	Off
Vibrate	On

• During Meeting Mode or when Vibrate is set to Vib. & Ring and Vib. → Ring, while handset is on charger:

Function	Status
Vibrate*	Off
Ringer	User Setting

\* Please note that, if you set the handset on the charger while receiving an incoming call, vibration will stop. Once the vibration stops, the handset will not vibrate again for that call, even if the handset is lifted up again. (If Quick Answer is set, lifting up the handset will answer the call.)

# Before Operating the Handset

## ◆◆ **Unsupported PBX Features**

The following PBX features are not supported when using a KX-TD7896:

- 1) **Turning Background Music (BGM) on and off.**
- 2) **Switching displays between “date and time” and “self extension number”.**
- 3) **Confirming the current time service mode (day/night/lunch).**
- 4) **Entering PBX System Programming mode.**

## ◆◆ **Selecting the Display Language**

You can select the desired language (English/Spanish/French).

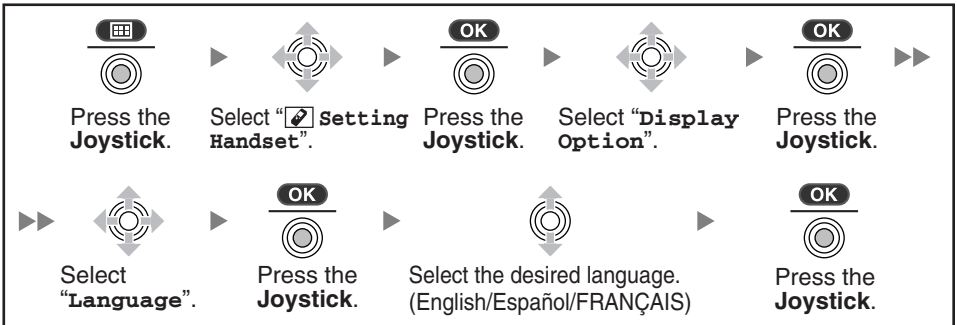

- The display language of both the handset and PBX can be selected, and both should be set to the same language. For more information, refer to the user documentation for your PBX.

# Before Operating the Handset

## ◆◆ Setting the Date and Time

If you selected “PBX Type-Type 2 (KX-TA308)” in the PBX Type setting, you should set a date and time.

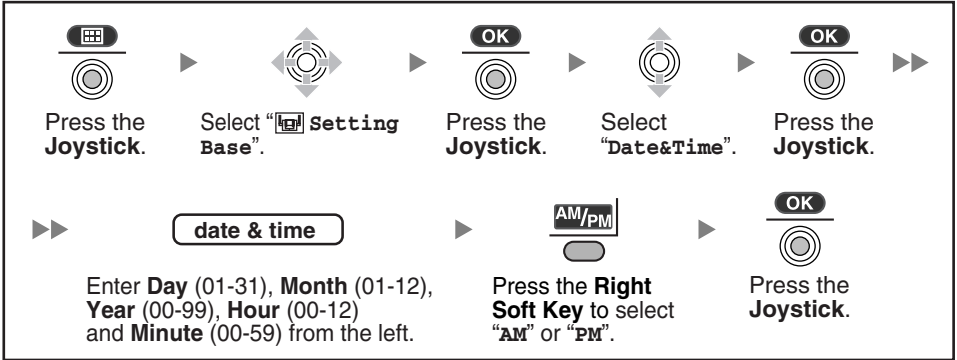

- Set the current date and time on the base unit. If you do not do so, the date and time of incoming calls will not be displayed correctly.

## ◆◆ Enabling the Outgoing Call Log

The default setting is “off” for the Outgoing Call Log. You can enable the Outgoing Call Log if needed.

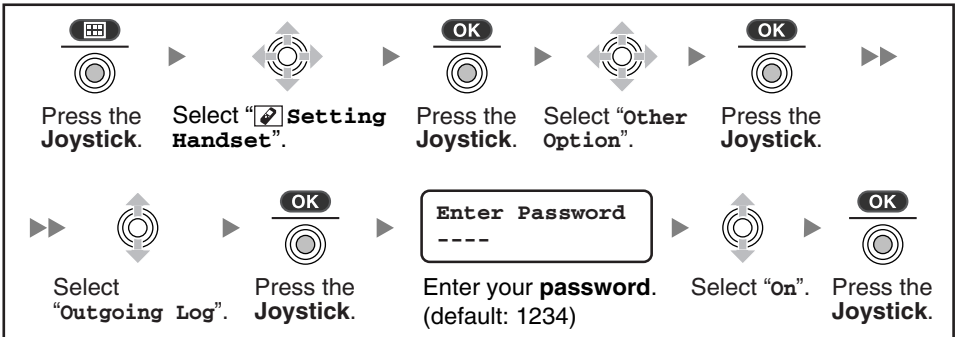

- Only the numbers you dial, or numbers dialed using Hot Key Dial or Phonebook will be stored in the Outgoing Call Log.

# Before Operating the Handset

## ◆◆ Entering the Standby Display Name

You can enter the name of the standby mode display of the handset.

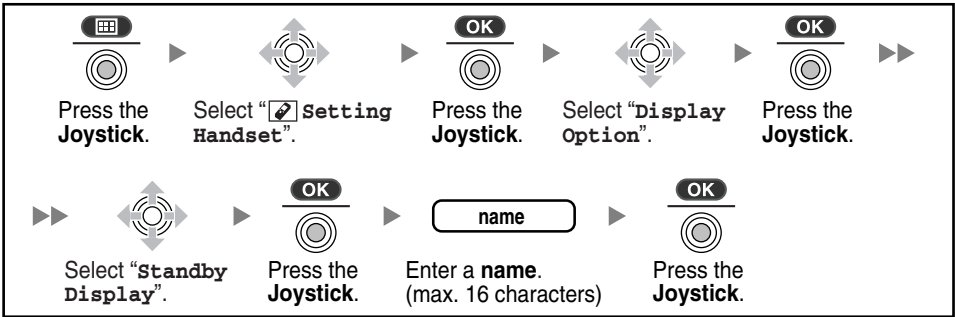

- To enter the name, see page 25.

## ◆◆ Entering the Names of the Flexible Keys

You can enter a name for each flexible key of the handset.

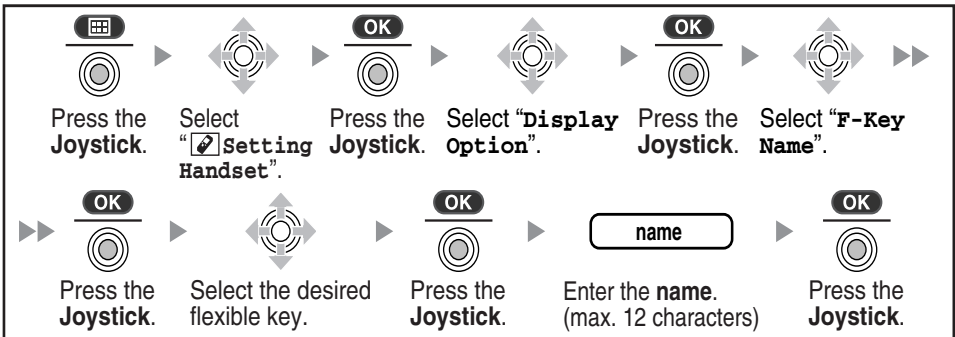

- To enter the name, see page 25.

# Before Operating the Handset

## ◆◆ Adjusting the Ringer Volume

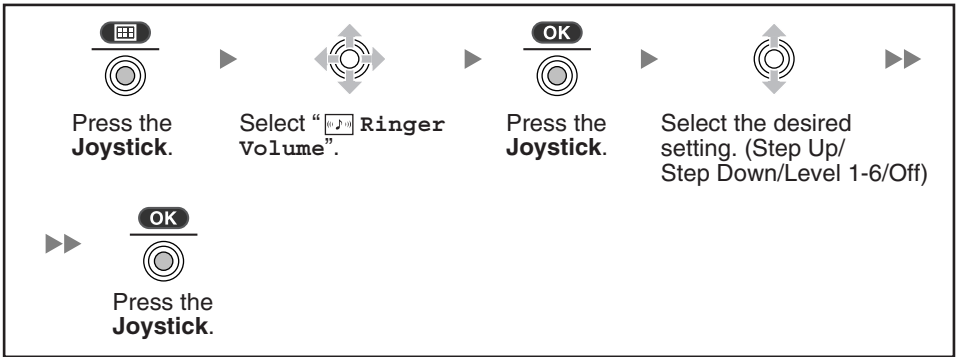

- For the ringer pattern, see page 31.

## ◆ Adjusting the Ringer Volume or Turning the Ringer Off While Ringing

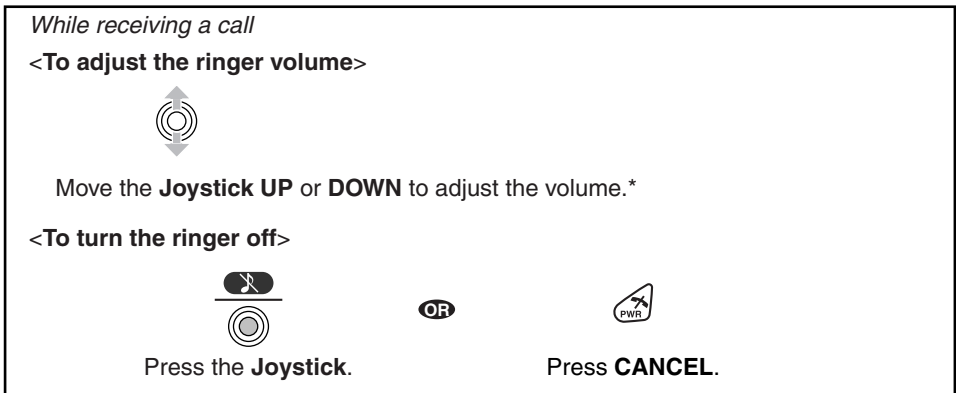

- \* The adjusted volume level will also be used for subsequent calls.
- If you attach the headset while receiving an incoming call, the ring from the handset does not switch to the headset. If you attach the headset before receiving an incoming call, and headset tone is set to on, a tone will be heard from the headset. If Vibrate is set to on, the handset will vibrate whether a headset is attached or not.



# Before Operating the Handset

## ◆◆ Adjusting the Vibrate Setting

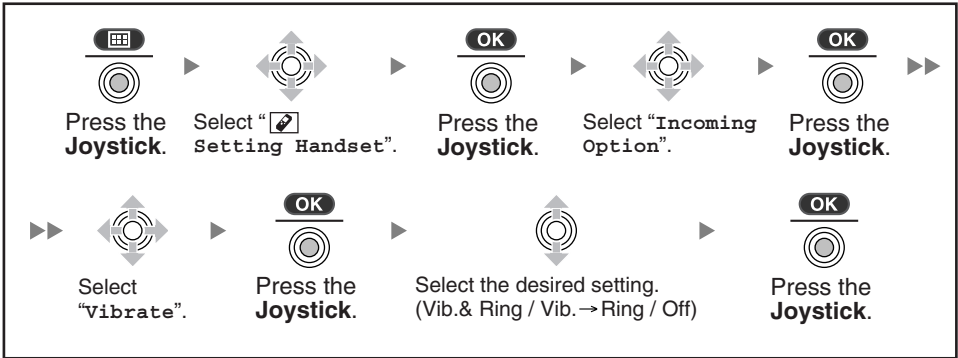

- You can receive an intercom call by the caller's voice instead of rings (**Voice Call**). For further information, refer to "Alternate Receiving—Ring/Voice" in the user documentation for your PBX.
- To set Vibrate only, without ringing, turn Meeting Mode on or set the Ringer Volume to off. (See page 8.)

## ◆◆ Adjusting the Receiver/Speaker/Headset Volume

*During a conversation*



Move the **Joystick UP** or **DOWN** to adjust the volume.  
(Receiver Volume-Level 1-4, Speaker Volume-Level 1-6, Headset Volume-Level 1-4)

# Handset Display

## ◆◆ Icons

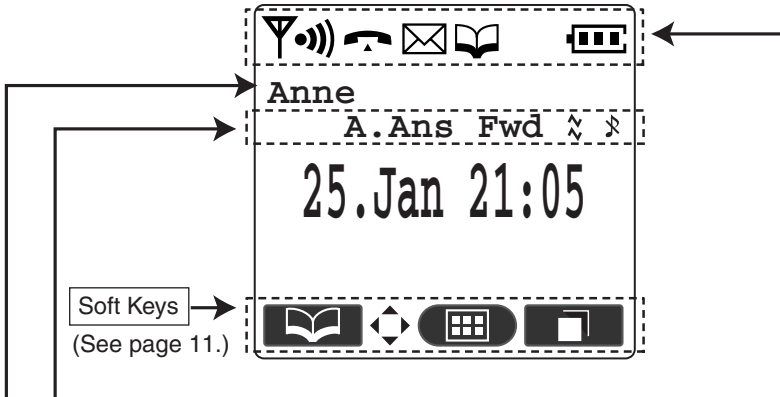

	Ringer Volume OFF (See page 8.)
	Vibrate (See page 9.)
<b>Fwd</b>	Call Forwarding (See page 21.)
<b>DND</b>	Do Not Disturb (See page 21.)
<b>A. Ans</b>	Auto Answer (For Hands-free Answerback, see page 18.)
<b>M</b>	Meeting Mode (See page 4.)





	Within range of a base unit
	Out of range If this icon flashes when making a call, move closer to the base unit and dial again.
	Intercom Indicator
	Off-hook Status
	Message Waiting
	Phonebook
	Battery Indicator

<p>&lt;Standby Mode&gt;</p> <p>For "Entering the Standby Display Name", see on page 7.</p>	<p>&lt;While Off-hook/During a Conversation&gt;</p> <p><b>Talk</b>                      Displayed during a conversation using the receiver.</p> <p><b>Speaker Phone</b>        Displayed during a conversation using the speaker (Hands-free mode).</p> <p><b>Headset</b>                    Displayed when a headset is attached.</p> <p><b>Headset (SP)</b>            Displayed when a headset is attached during Hands-free mode.</p> <p>            Mic Mute Flashes when Mic Mute is on.</p>
--	--





## ◆◆ Soft Keys

Icons and information shown on the display will vary depending on the state of use. To select an item shown on the display, press the corresponding soft keys.



### Handset Phonebook

-  Opens the Phonebook. Pressing this key for more than 2 seconds locks the Phonebook.
-  Displayed when in Phonebook Lock. Pressing this key then entering the password (default: 1234), unlocks the Phonebook temporarily. Pressing for more than 2 seconds, then entering the password (default: 1234), unlocks the Phonebook.
-  Stores a new item in the Phonebook.
-  Searches for an item in the Phonebook alphabetically.



### Entering Characters

-  Displayed when in Alphabetic character entry mode. Pressing this key switches to Numeric character entry mode.
-  Displayed when in Numeric character entry mode. Pressing this key switches to Special character entry mode.
-  Displayed when in Special character entry mode. Pressing this key switches to Alphabetic character entry mode.
-  Inserts a dialing pause.
-  Clears digits or characters.











### Sounds

-  Turns the microphone mute on or off during a conversation.
-  Turns the ringer off.

### PBX Features

-  Establishes a multiple-party conversation (Conference).
-  Displayed when a phone number contains over 15 digits. Pressing these keys displays the rest of the phone number. Pressing while in PBX Personal programming mode, moves to the next or previous display.

### Others

-  Opens the main menu. Pressing this key for more than 2 seconds locks all keys.
-  Returns to the previous display.
-  Opens the list menu (edit/delete in the Phonebook, etc.).
-  Confirms the entry.
-  Displayed when in Key Lock mode. Pressing this key for more than 2 seconds unlocks the keys.
-  Advances to the next display.
-  Displays the Outgoing Call Log.
-  Sets the display format of Date&Time set in "Setting Base". (See page 6.)
-  Selects an item when in setting mode.
-  Displayed when there is no soft key icon.
-  Displayed when it is possible to use an arrow key to make a selection.

# Handset Display

## ◆◆ Operation Outline

Handset functions are accessed through the display menu, and selected with the joystick and soft keys. The guidance display is shown in standby mode for easy operation.

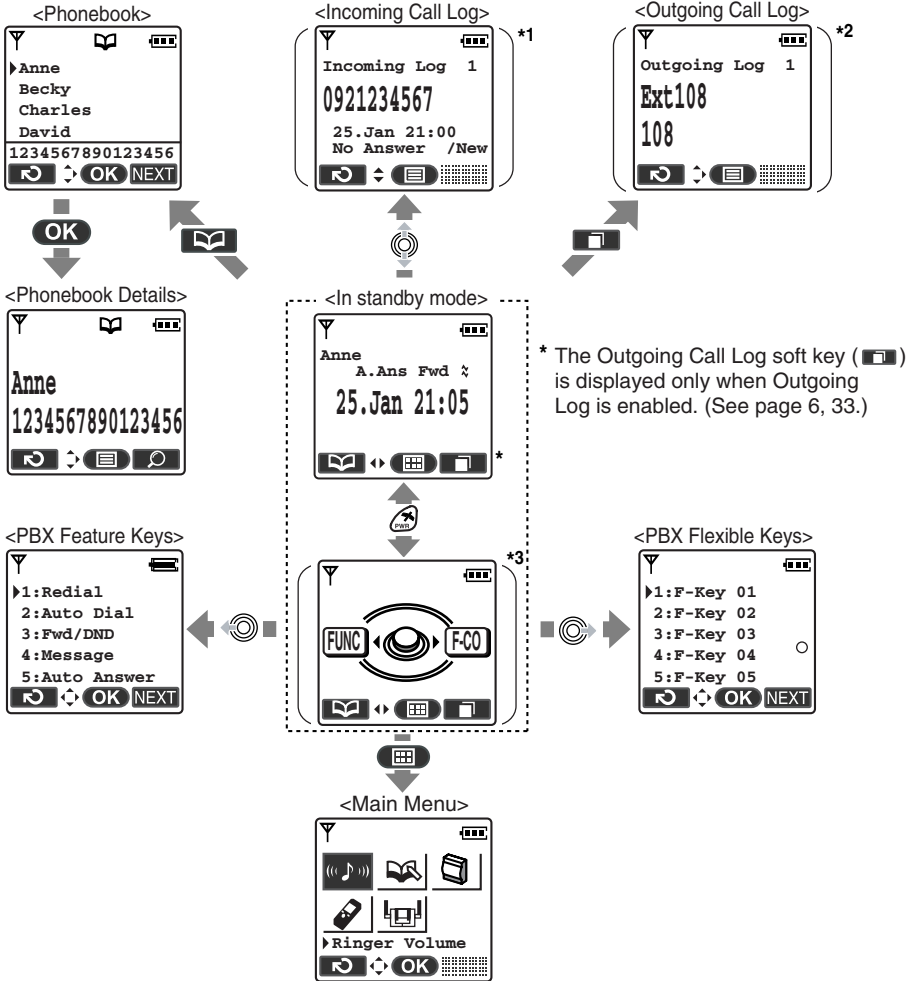

- These functions cannot be accessed while in key lock mode.
- The displays marked with [ ] are only shown when the following values have been set:
  - \*1 Setting Base: PBX Type → Type 2 (KX-TA308)/Date&Time/Incoming Log (See page 34.) You cannot make a call using the Incoming Call Log.
  - \*2 Setting Handset → Other Option → Outgoing Log → On (See page 6, 33.)
  - \*3 Setting Handset → Display Option → Guidance → On (See page 33.)

## ◆ Function Menus

Press the joystick to display the main and sub menus.

### Main Menu—While in Standby Mode

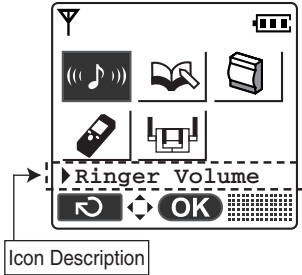

#### **Ringer Volume:**

Accesses the “Ringer Volume” setting.



#### **New Phonebook:**

Stores a new item in the Phonebook.



#### **PBX Program:**

Enters PBX Personal Programming mode. For PBX Personal Programming, refer to the user documentation for your PBX. Press  to exit from PBX Personal Programming mode.



#### **Setting Handset:**

Accesses the “Setting Handset” settings.



#### **Setting Base:**

Accesses the “Setting Base” settings.

### Sub Menu—While Off-hook/During a Conversation



#### **Phonebook:**

Opens the Phonebook.



#### **New Phonebook:**

Stores a new item in the Phonebook.



#### **Outgoing Call Log:**

Enters the Outgoing Call Log.

\*1 The Outgoing Call Log icon is displayed only when Outgoing Log is enabled. (See page 6, 12, 33.)



#### **Incoming Call Log:**

Enters the Incoming Call Log.

\*2 The Incoming Call Log icon is displayed if you selected “PBX Type-Type 2 (KX-TA308)” in the PBX setting. (See page 12, 34.)

# Handset Display

## ◆ PBX Feature Keys

Handset functions can be activated through the display key list. Move the joystick left to display the feature key list.

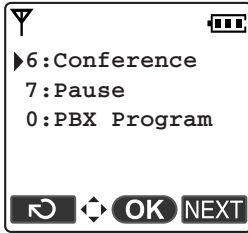
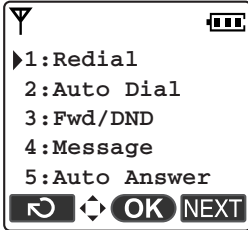

### 1:Redial:

Redials the last dialed number.

### 2:Auto Dial:

Makes a call through PBX System Speed Dialing.

### 3:Fwd/DND:

Displays and/or sets Call Forwarding or Do Not Disturb.

### 4:Message:

Leaves a message waiting indication, or calls back the party who left you a message waiting indication when ☒ is displayed.

### 5:Auto Answer:

Answers an incoming intercom call automatically in hands-free mode. "A. Ans" is displayed in standby mode.

### 6:Conference:

Establishes a multiple-party conversation.

### 7:Pause\*1:









Inserts a dialing pause.

### 0:PBX Program\*2:

Enters PBX Personal Programming mode. Press  to exit from PBX Personal Programming mode.



- \*1 Displayed only during a conversation or PBX Personal Programming mode.
- \*2 Displayed only while in standby mode or PBX Personal Programming mode.
- For PBX Personal Programming, refer to the user documentation for your PBX.

Combination Keys			
	<b>Redial</b>		<b>Auto Answer</b>
	<b>Auto Dial</b>		<b>Conference</b>
	<b>Fwd/DND</b>		<b>Pause</b>
	<b>Message</b>		<b>PBX Program</b>



- For operation, see page 16.

## ◆ PBX Flexible Keys

A flexible key can be used either to seize a line in order to make or receive an outside call (F-Key), or used as a function key. Move the Joystick right to display the flexible key list. Here you can access the 12 flexible keys. The icon shown beside each F-Key indicates line status similarly to the LED indicators on a PT: ● is the same as a green LED; ○ is the same as a red LED.



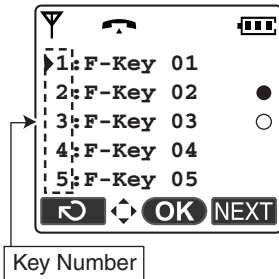

Example:



### Understanding the F-Key Icons \*





- (on): You are currently using this line.
- (flashing slowly): You have a call on hold on this line.
- (on): This line is in use by someone else.
- (flashing rapidly): There is an incoming call on this line.
- (flashing slowly): Someone has a call on hold on this line.
- (no icon): This line is idle.



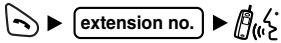
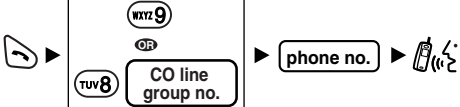
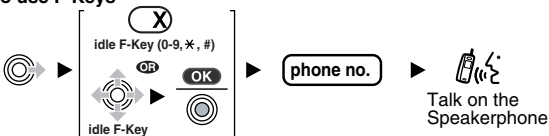

- \* The meanings of these icons vary depending on the status of the CO line.
- For further information, refer to “LED Indication” in the feature documentation for your PBX.
- To select a key, press its key number, or move the Joystick  to select the desired key then press  (hands-free mode) or  (receiver). For operation, see “Receiving—An Outside Call on a specific line” on page 18.
- To go to the next or previous display, move the Joystick .
- To go to the next display, press .

# Operation for the KX-TA308/624/824

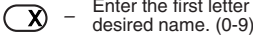
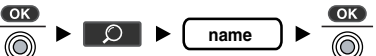
For further information, refer to the user documentation for your PBX or consult your dealer.

Desired Function	Operation
<b>Making Calls</b>	
Calling	<p><b>To an extension</b></p>  <p><b>To an external party</b></p> 
	<p><b>To use F-Keys</b></p>  <p>-----</p>  <p style="text-align: center;">idle F-Key</p>
	<p><b>To use Hot Key Dial</b></p>  <p>Press the dialing key for more than 1 second.</p>
	<p><b>To use the Outgoing Call Log*1</b></p> 
	<p><b>To use the Phonebook</b></p>  <p><b>&lt;Direct Search&gt;</b> OR</p>  <p>Enter the first letter of the desired name. (0-9)</p> <p><b>&lt;Name Search&gt;</b> OR</p>  <p style="text-align: right;">• To enter a character, press the corresponding dialing key repeatedly until the character is displayed.</p>

- You can confirm a number was dialed correctly before calling (**Predialing**) by entering the number, then pressing .
- To clear an entire number while predialing, press  for more than 1 second.
- \*1 Only the numbers you dial, or numbers dialed using Hot Key Dial or Phonebook will be stored in the Outgoing Call Log. Note that, the Outgoing Log setting of your handset must be set to on for this feature to operate. (See page 6, 33.)  
Any Password or Account Code you enter will also be stored in the Outgoing Call Log. Therefore, for security purposes please delete as necessary. (See page 28.)
- To store an item in the Phonebook or as a Hot Key, see page 23 or 24.

























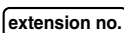





























# Operation for the KX-TA308/624/824

Desired Function	Operation
<b>Making Calls</b>	
Redial* <sup>1</sup>	
One-touch Dialing	<b>To program</b> 
	<b>To dial</b> 
Calling an operator	
Speed Dialing (Personal)	<b>To store</b> 
	<b>To dial</b> 
Speed Dialing (System)	<b>To dial</b> 
Calling back a caller using the Incoming Call Log (KX-TA624/824 only)	<b>To program</b> 
	<b>To dial</b> 

\* Caller ID is displayed for about 20 seconds. If you press during that time period, the display goes blank until the time expires. While Caller ID is displayed or the display is blank, you cannot receive a call, make a call using or enter PBX Personal Programming mode. To return to the standby display, press then press .











































































































\*<sup>1</sup> You can use the last number stored in the PBX to make calls (Last Number Redial). However, in this case the number will not be stored as a new entry in the Outgoing Call Log. To display the last number you dialed, press .

# Operation for the KX-TA308/624/824

Desired Function	Operation	
<b>Receiving Calls</b>		
Receiving	<p><b>An Intercom Call/An Outside Call</b></p>  <p><b>An Outside Call on a specific line</b></p> 	<p><b>An Intercom Call</b></p>  <p>Talk on the Speakerphone.</p>  <p><b>An Outside Call on a specific line</b></p>  <p>rapidly flashing F-Key (0-9, *, #)</p>  <p>rapidly flashing F-Key</p>  <p>OK</p>  <p>Talk on the Speakerphone.</p> <p>OR</p>  <p>rapidly flashing F-Key</p>  
Picking up a call	 <p><b>Directed</b></p>  <p>GHI 4</p>  <p>extension no.</p> <p><b>Group</b></p>  <p>GHI 4</p>  <p>OPER 0</p> 	
Hands-free Answerback (Auto Answer)	<p><b>An Intercom Call To set/cancel</b></p>  <p>rapidly flashing F-Key</p>  <p>JKL 5</p>	
Live Call Screening* <sup>1</sup> (LCS)	Hands-free mode	<p><b>To answer the call</b></p>  <p>OR</p>  <p>rapidly flashing F-Key</p>  <p>LCS Key (0-9, *, #)</p>  <p>rapidly flashing F-Key</p>  <p>LCS Key</p>  <p>OK</p>  <p><b>To stop monitoring</b></p>  <p>RCL FLASH</p> <p>OR</p>  <p>PWR</p> <p>OR</p>  <p>rapidly flashing F-Key</p>  <p>LCS Cancel Key (0-9, *, #)</p>  <p>rapidly flashing F-Key</p>  <p>LCS Cancel Key</p>  <p>OK</p>
	Private mode	<p><b>To start monitoring</b></p>  <p><b>To stop the alert tone</b></p>  <p>RCL FLASH</p> <p>OR</p>  <p>rapidly flashing F-Key</p>  <p>LCS Cancel Key (0-9, *, #)</p>  <p>rapidly flashing F-Key</p>  <p>LCS Cancel Key</p>  <p>OK</p> <p>-----</p> <p><i>While monitoring</i></p> <p><b>To answer the call</b></p>  <p>OR</p>  <p>rapidly flashing F-Key</p>  <p>LCS Key (0-9, *, #)</p>  <p>rapidly flashing F-Key</p>  <p>LCS Key</p>  <p>OK</p>  <p><b>To stop monitoring</b></p>  <p>RCL FLASH</p> <p>OR</p>  <p>rapidly flashing F-Key</p>  <p>LCS Cancel Key (0-9, *, #)</p>  <p>rapidly flashing F-Key</p>  <p>LCS Cancel Key</p>  <p>OK</p>

\*<sup>1</sup> This feature is available when the PBX is connected to a Panasonic Voice Processing System (VPS). For setting LCS, refer to the user documentation for your PBX.

# Operation for the KX-TA308/624/824

Desired Function	Operation								
<b>When the Dialed Extension is Busy/No Answer</b>									
Automatic Callback Busy	<b>To set</b> <i>While hearing a busy tone</i>  ► 	<b>To answer</b> <i>If you hear callback ringing</i>  ► 							
Message Waiting	Sender	<b>To leave a notification</b> <i>When the receiver's extension is busy or does not answer</i>  ►  ►  <hr/> <b>To cancel a notification</b>  ► <span style="border: 1px solid black; padding: 2px;">receiver's extension no.</span> ►  ►  ►  ►  ► 							
	Receiver	<b>To call back</b>  ►  ►  ►  <hr/> <b>To clear all notifications</b>  ►    ►  ► 							
Call Waiting	Sender	<i>While hearing a busy tone</i>  ► Wait for an answer. ► 							
	Receiver	<b>To set/cancel</b> <div style="display: flex; align-items: center;">  ► <div style="margin: 0 10px;"> <p><b>For outside calls</b></p> <table border="0" style="border-collapse: collapse;"> <tr> <td style="border: 1px solid black; padding: 5px;">      </td> <td style="padding-left: 10px;">Set</td> </tr> <tr> <td style="border: 1px solid black; padding: 5px;">      </td> <td style="padding-left: 10px;">Cancel</td> </tr> </table> </div>  </div> <p><b>For intercom calls/doorphone calls</b></p> <table border="0" style="border-collapse: collapse;"> <tr> <td style="border: 1px solid black; padding: 5px;">      </td> <td style="padding-left: 10px;">Set</td> </tr> <tr> <td style="border: 1px solid black; padding: 5px;">      </td> <td style="padding-left: 10px;">Cancel</td> </tr> </table>	    	Set	    	Cancel	    	Set	    
    	Set								
    	Cancel								
    	Set								
    	Cancel								
<b>To talk to the new party</b> ( <i>While hearing the Call Waiting tone</i> ) <b>To terminate a current status</b>  ►  ►  <hr/> <b>To hold and then talk to the new party</b>  ► <div style="display: flex; align-items: center;"> <div style="margin: 0 10px;"> <p><b>lit F-Key (0-9, *, #)</b></p> <table border="0" style="border-collapse: collapse;"> <tr> <td style="border: 1px solid black; padding: 5px;">  ►  </td> <td style="padding-left: 10px;">lit F-Key (0-9, *, #)</td> </tr> <tr> <td style="border: 1px solid black; padding: 5px;">  ►  ►  </td> <td style="padding-left: 10px;">OK</td> </tr> </table> </div>  </div> <p><b>lit F-Key</b></p> <p><b>INT</b></p> <ul style="list-style-type: none"> <li>Disregard this step if both parties are extensions.</li> </ul>	 ► 	lit F-Key (0-9, *, #)	 ►  ► 	OK					
 ► 	lit F-Key (0-9, *, #)								
 ►  ► 	OK								

# Operation for the KX-TA308/624/824

Desired Function	Operation
<b>During a Conversation</b>	
Transferring a call* <sup>1</sup>	<p>extension no. to an extension OK phone no. to an external party Announce.</p>
Holding a call* <sup>2</sup>	<p><b>To hold</b></p> <p><b>To retrieve a call at the holding extension</b></p>
	<p><b>To retrieve an outside call from another extension</b></p>
Holding a call exclusively* <sup>2</sup>	<p><b>To Hold</b></p> <p>• You can hold a call exclusively so that other people cannot retrieve the call.</p> <p><b>To retrieve a call on exclusive hold</b></p>
Three-party conference	<p>third party's no. Announce. Announce.</p>
<b>Useful Features</b>	
Paging* <sup>3</sup>	<p><b>To page</b></p> <p>All extensions DEF 3 DEF 3 OPER 0 Group DEF 3 DEF 3 group no. All external speakers DEF 3 GHI 4 All extensions &amp; external speakers DEF 3 DEF 3 ←→* Announce.</p>
	<p><b>To answer an announced page</b> Through a telephone speaker</p>

\*<sup>1</sup> To return to the call before the destination answers, press or , or select the corresponding F-Key.



\*<sup>2</sup> When you hold several outside calls, you need to assign the F-Keys (Single-CO/Group-CO/Other-CO) to a flexible key as necessary, beforehand.

\*<sup>3</sup> While making a paging announcement, battery consumption is the same as that of a normal conversation.

# Operation for the KX-TA308/624/824

Desired Function	Operation
<b>Useful Features</b>	
Setting Absent Message	► <b>PGRS7</b> <b>JKL5</b> ► <b>message no.</b> ► <b>parameter (if required)</b> ► <b>#</b> ►
Clearing the setting	► <b>PGRS7</b> <b>WXYZ9</b> <b>#</b> ►
Log-in/Log-out	► [ <b>PGRS7</b> <b>DEF3</b> <b>MNO6</b> <b>OPER0</b> <b>#</b> Log-in ] <b>PGRS7</b> <b>DEF3</b> <b>MNO6</b> <b>1</b> <b>#</b> Log-out ] ►
Do Not Disturb (DND)	►  ► <b>DEF3</b> ► [ <b>GH14</b> Set ] <b>OPER0</b> Cancel ] ► <b>#</b> ►
Call Forwarding (Fwd)	►  ► <b>DEF3</b> ► <div style="border-left: 1px solid black; border-right: 1px solid black; padding: 5px; margin: 10px 0;"> <p><b>All calls</b>  <b>1</b> ► <b>extension no.</b></p> <p><b>Busy/No answer</b>  <b>ABC2</b> ► <b>extension no.</b></p> <p><b>To a CO line</b>  <b>DEF3</b> ► <b>line access code</b> ► <b>phone no.</b></p> <p><b>Follow Me</b>  <b>JKL5</b> ► <b>your extension no.</b></p> <p><b>Follow Me Cancel</b>  <b>TUV8</b> ► <b>your extension no.</b></p> <p><b>Cancel</b>  <b>OPER0</b></p> </div> <p>► <b>#</b> ► </p> <p><b>To Voice Processing System (VPS)</b>  <input type="checkbox"/> KX-TA624/824 only</p> <div style="border-left: 1px solid black; border-right: 1px solid black; padding: 5px; margin: 10px 0;"> <p><b>All calls</b>  <b>1</b> ► <b>VPS extension no.</b></p> <p><b>Busy/No answer</b>  <b>ABC2</b> ► <b>VPS extension no.</b></p> </div>
Locking your extension	► [ <b>PGRS7</b> <b>PGRS7</b> <b>lock code*</b> <b>lock code*</b> ► <b>#</b> Lock ] <b>PGRS7</b> <b>PGRS7</b> <b>lock code*</b> ► <b>#</b> Unlock ] ► <p style="text-align: center;">* The lock code contains 4 digits.</p>

# Operation for the KX-TA308/624/824

Desired Function	Operation											
<b>Making Use of the Voice Mail Service (KX-TA624/824 only)</b>												
Listening to a message	From your own extension	 ► <b>VPS extension no.</b> ► ► <b>VPS password*</b> <b>#</b> • If you have no password, you can skip the last step.										
	From someone else's extension	 ► <b>VPS extension no.</b> ► ► <b>#</b> <b>MNO6</b> ► <b>A-e*</b> ► ► <b>mailbox no.</b> ► ► <b>VPS password*</b> <b>#</b> • If you have no password, you can skip the last step.										
Leaving a message	 ► <b>VPS extension no.</b> ► ► <b>VPS password*</b> <b>#</b> ► <b>ABC2</b> ► ► <b>#</b> <b>MNO6</b> ► <b>A-e*</b> ► <b>mailbox no.</b> ► <b>VPS password*</b> <b>#</b> ► <b>ABC2</b> ► • If you have no password, you can skip the last step. ► <b>#</b> <b>1</b> ► Enter the first 3 or 4 letters of the desired name ► <b>1</b> <b>1</b> ► Leave a message ► ► <b>1</b> <b>ABC2</b> ► <table border="1" data-bbox="456 959 804 1102" style="margin-left: 20px;"> <tr> <td colspan="2" style="text-align: center;"><b>To send the message immediately</b></td> </tr> <tr> <td><b>1</b> <b>ABC2</b></td> <td><input type="checkbox"/> KX-TVA series</td> </tr> <tr> <td><b>ABC2</b></td> <td><input type="checkbox"/> KX-TVS series</td> </tr> <tr> <td colspan="2" style="text-align: center;"><b>To set the delivery time</b></td> </tr> <tr> <td><b>1</b> <b>1</b></td> <td>► Follow the guidance</td> </tr> </table>		<b>To send the message immediately</b>		<b>1</b> <b>ABC2</b>	<input type="checkbox"/> KX-TVA series	<b>ABC2</b>	<input type="checkbox"/> KX-TVS series	<b>To set the delivery time</b>		<b>1</b> <b>1</b>	► Follow the guidance
	<b>To send the message immediately</b>											
<b>1</b> <b>ABC2</b>	<input type="checkbox"/> KX-TVA series											
<b>ABC2</b>	<input type="checkbox"/> KX-TVS series											
<b>To set the delivery time</b>												
<b>1</b> <b>1</b>	► Follow the guidance											
During playback	<input type="checkbox"/> <b>OPER 0</b> Repeat Voice Guidance <input type="checkbox"/> <b>A-e*</b> Exit Menu											

- KX-TVA series
  - 1** Listen to Message
  - ABC2** Deliver Message
  - DEF3** Mailbox Management
  - GHI4** Automated Attendant
  - JKLM5** Message Notification
  - MNO6** Other Features
  - A-e\*** End Call
- KX-TVS series
  - 1** Listen to Message
  - ABC2** Deliver Message
  - DEF3** Check Mailbox Distribution
  - GHI4** Automated Attendant
  - JKLM5** Mailbox Management
  - MNO6** Other Features
  - A-e\*** End Call

- \* For more information on the VPS password, refer to the user documentation for the VPS.
- Some feature access numbers may vary depending on the market. Please consult your local dealer for the details.

## ◆◆ Handset Phonebook

You can store up to 200 items with names, phone numbers and category numbers in the handset for easy access. You can set unique Ringer/LED/Vibrate patterns for each category to identify incoming calls. All Phonebook items are stored in alphabetical order. For security purposes, you can lock the Phonebook. To make a call using the Phonebook, Outgoing Call Log or Hot Key Dial, see page 16.

## ◆ Incoming Call Identification (Private Ring)

You can organize entries in the Phonebook into one of 9 categories. A call from someone stored in one of these categories will be indicated by the ringer pattern, ringing indication (LED) color pattern and vibrate pattern assigned to the category ("Private Ring-Category 1-9").

Item	Setting
Ringer pattern	6 bells, 9 melodies (See page 31.)
LED pattern	4 patterns (See page 31.)
Vibrate pattern	7 patterns (See page 31.)





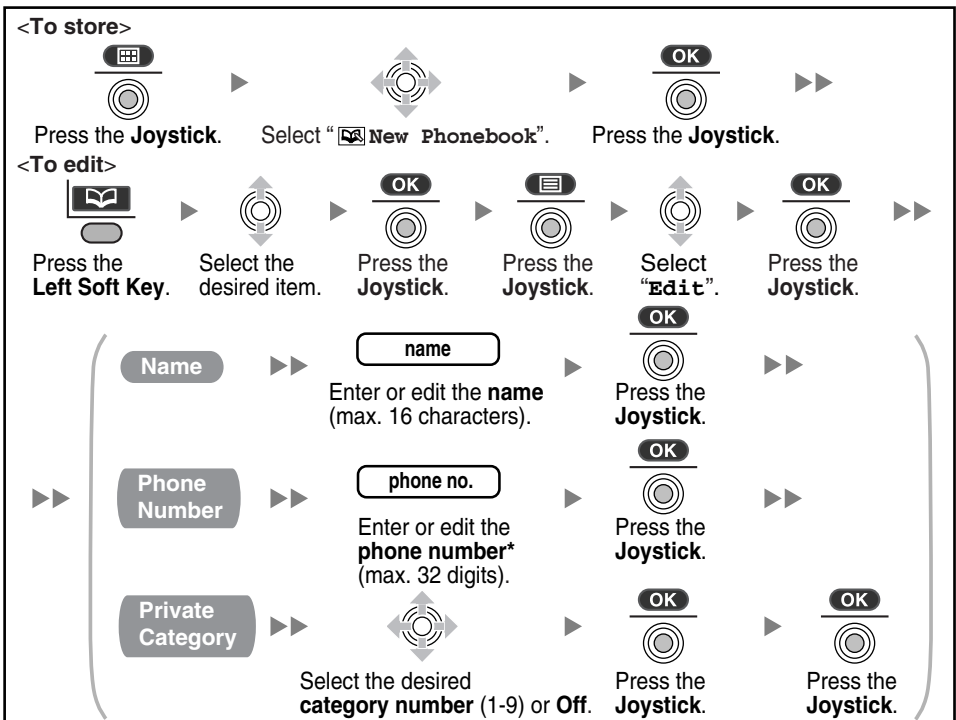

## ◆◆ Storing an Item in the Handset Phonebook

### ◆ Storing a New Item and Editing a Stored Item



# Using the Handset Phonebook



- To enter characters, see page 25.
- \* The valid digits are “0” through “9”, “\*”, “#”, “P (  )” and “F (  )”.
- \* Although up to 200 Phonebook items can be stored, each phone number stored in the Phonebook that contains over 24 digits counts as two Phonebook items.
- \* If there is only one Phonebook memory location available left, you cannot store a phone number that is over 24 digits long.
- To change a character or digit, move the joystick  to highlight it, press  to delete it, then enter the new character or digit.
- To clear an entire line, press  for more than 1 second.
- To move the cursor to the left or right, move the joystick  or , respectively.

## ◆ Storing an Item Using the Outgoing Call Log

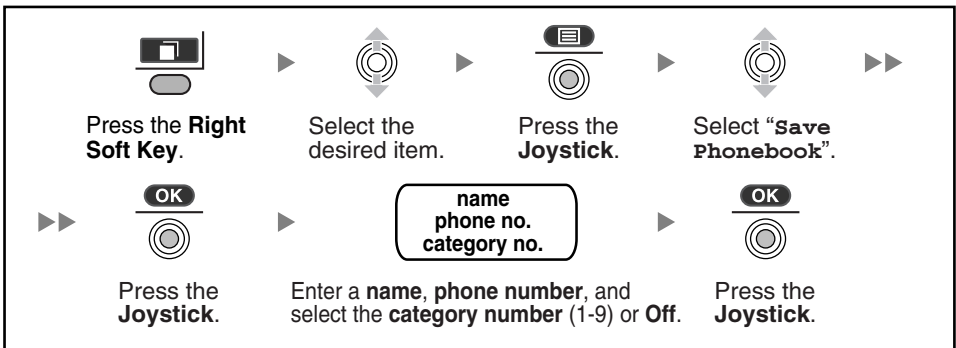

## ◆ Storing a Handset Phonebook Number as Hot Key Dial

A phone number stored in the Phonebook can be assigned as a Hot Key.

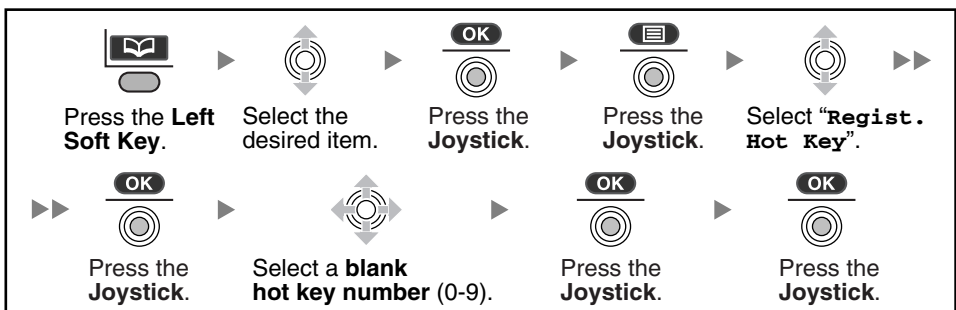

- A “√” will be displayed next to hot key numbers that have a Phonebook item registered to them.



## ◆◆ Entering Characters

You can enter characters and digits using the dialing keys.

You can select one of 3 character modes by pressing the **Right Soft Key** while entering a name. The function icon above the soft key displays the current character mode.

See “Character Mode Table” (page 26) for available characters.

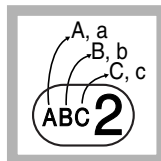

To change the character mode while editing a name in the Phonebook, press the **Right Soft Key**.

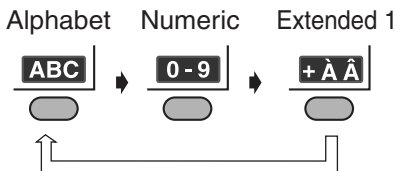

**Example:** To enter “Anne” in Alphabet Mode.

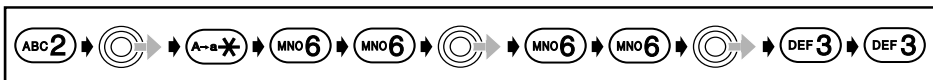

- To switch between uppercase and lowercase, press **A-a X**.
- To enter a character located on the same dialing key as the previous character, move the cursor by moving the Joystick **⦿**, then enter the desired character.
- If you enter a different character by mistake, move the Joystick **⦿** to highlight the character, press **XFER CLR** to delete it, then enter the correct character.
- To clear an entire line, press **XFER CLR** for more than 1 second.
- To move the cursor, move the Joystick **⦿**.

# Using the Handset Phonebook

## ◆ Character Mode Table

Keys	ABC (Alphabet)	0-9 (Numeric)	+AA (Extended 1)
<b>1</b>	Space # & ' ( ) * , - . / 1	1	Space # & ' ( ) * , - . / 1
<b>ABC 2</b>	ABC 2	2	AÀÁÂÃÄÅÆBCÇ 2
	abc 2		aàáâãäåæbcç 2
<b>DEF 3</b>	DEF 3	3	DEÈÉÊËËËËF 3
	def 3		deèéêëëëf 3
<b>GHI 4</b>	GHI 4	4	GĞHIÍÎÏÏÏÏÏ 4
	ghi 4		gğhiíîïïïïï 4
<b>JKL 5</b>	JKL 5	5	JKL 5
	jkI 5		jkI 5
<b>MNO 6</b>	MNO 6	6	MNÑOOÓÔÕÖØ 6
	mno 6		mñoóóóóóöø 6
<b>PQRS 7</b>	PQRS 7	7	PQRSŞß 7
	pqr s 7		pqr sŞß 7
<b>TUV 8</b>	TUV 8	8	TUÙÚÛÜÛÛÛ 8
	tuv 8		tuùúúúúÛv 8
<b>WXYZ 9</b>	WXYZ 9	9	WŴXYŷZ 9
	wxyz 9		wŴxyŷz 9
<b>OPER 0</b>	Space 0	0	Space 0

- Press **(↔\*)** before or after entering a character to change between uppercase and lowercase.
- For example, to enter the letter “C”, press **(ABC 2)** three times.

# Using the Handset Phonebook

## ◆◆ Locking the Handset Phonebook

You can lock/unlock the Phonebook while the handset is in standby mode.

### ◆ Locking the Handset Phonebook

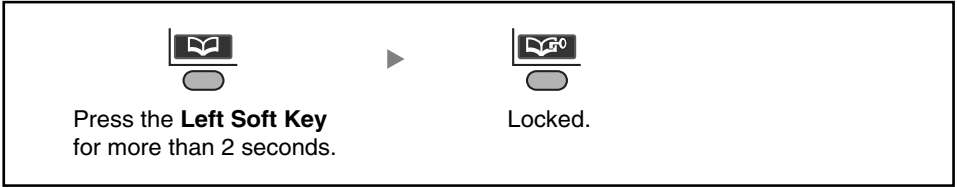

### ◆ Unlocking the Handset Phonebook

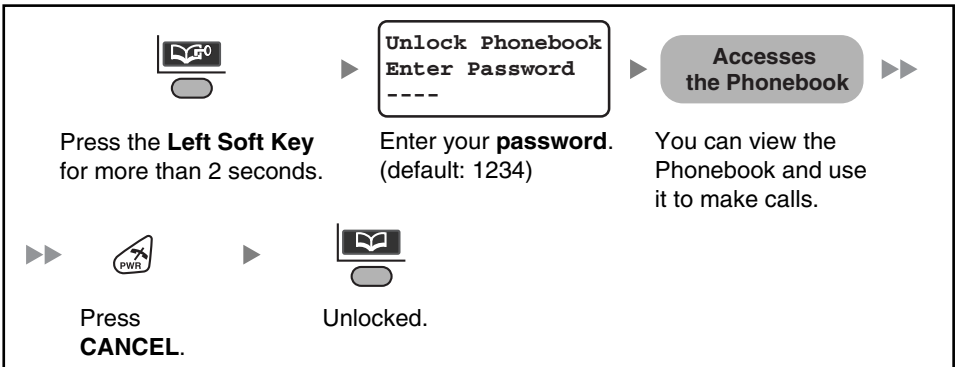

### ◆ Unlocking the Handset Phonebook Temporarily

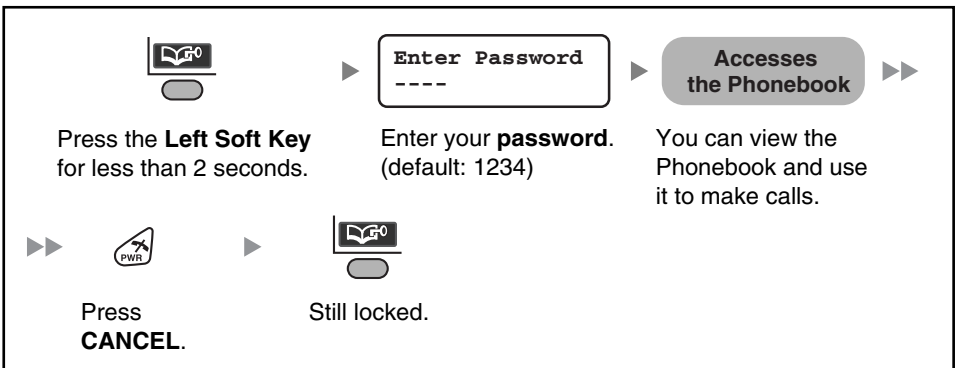

# Deleting Stored Items

## ◆◆ Deleting Stored Items in Handset Phonebook/Hot Key Dial/Incoming Call Log/Outgoing Call Log

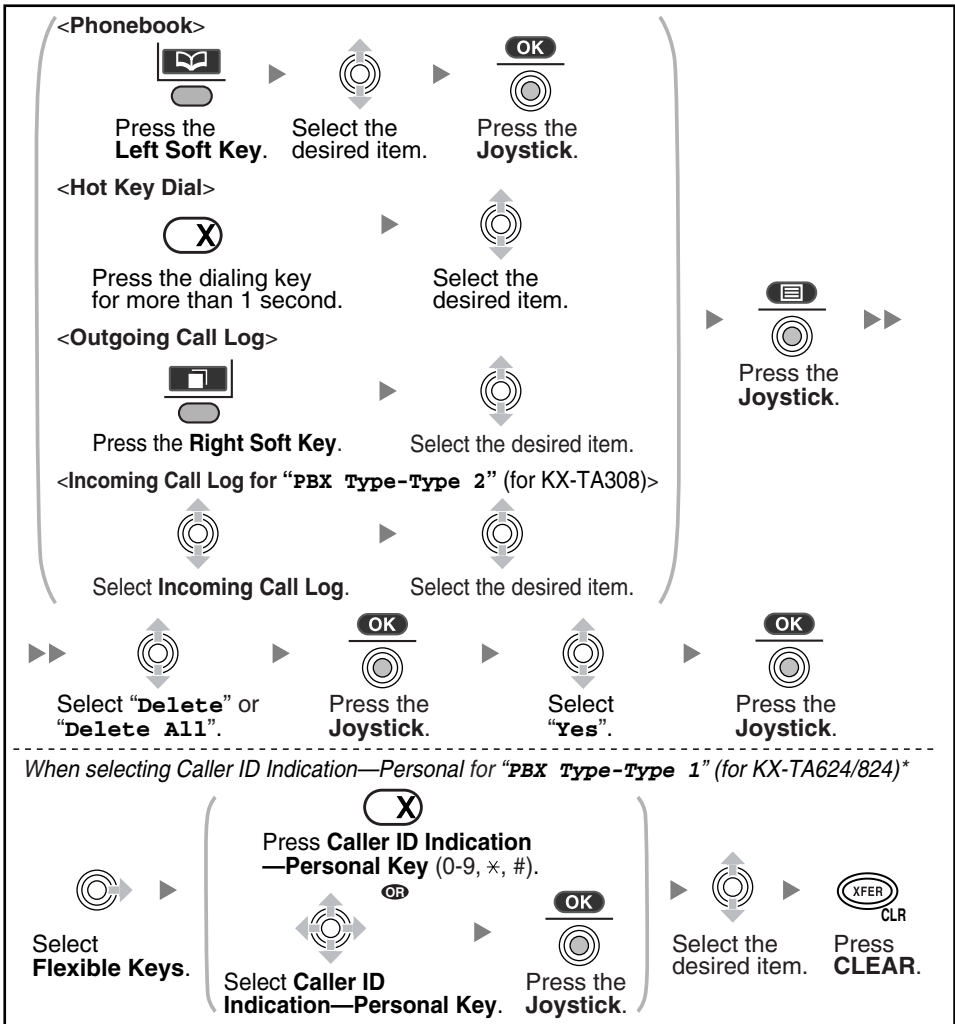



- If you delete a Phonebook item that you also stored as a Hot Key, the Hot Key Dial is also deleted. (See page 24.)
- \* To delete all information in the Incoming Call Log stored in the personal and common areas or information in the Incoming Call Log stored in the common area, refer to the user documentation for your PBX.

# Setting the Handset and Base Unit

## ◆◆ Setting the Handset and Base Unit

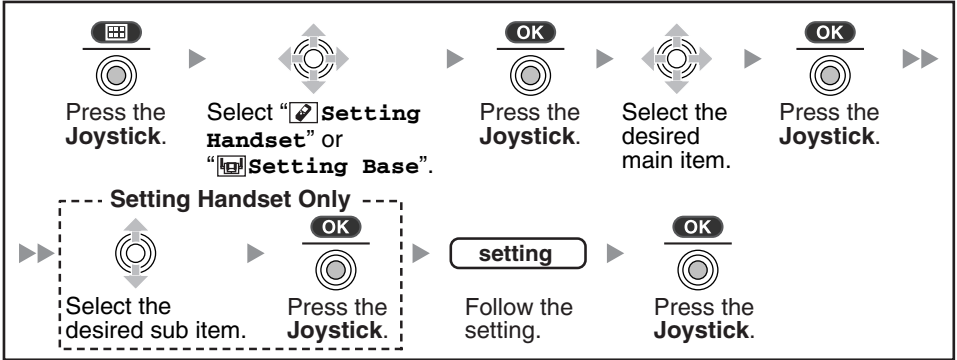
You can customize the handset and base unit by editing the settings found under “Setting Handset” or “Setting Base” in the menu list, as follows:



- To return to the previous menu, press .
- To cancel, press  at any time.
- The unit will beep to indicate that the new settings have been saved.
- For more information, refer to “Handset and Base Unit Menu Layout” on page 30.

# Setting the Handset and Base Unit

## ◆ Handset and Base Unit Menu Layout

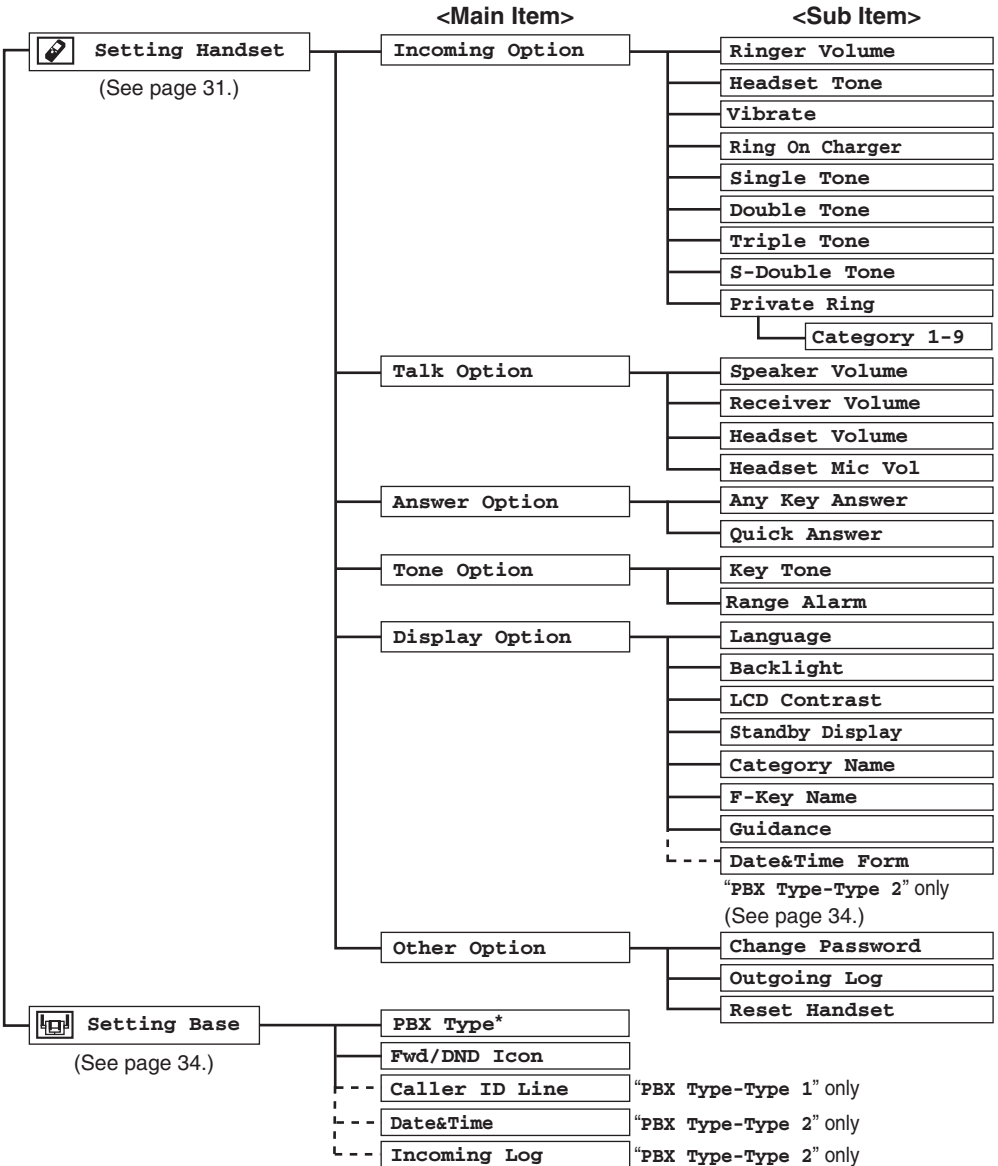

\* There are 2 types of PBX

PBX Type	PBX Models
Type 1	KX-TA624/824
Type 2	KX-TA308

# Setting the Handset and Base Unit

Main Item	Sub Item	Description	Setting	Default
Incoming Option	Ringer Volume	Adjusts the ringer volume.	<input type="checkbox"/> Step Up <input type="checkbox"/> Step Down <input type="checkbox"/> Level 1-6 <input type="checkbox"/> Off	Level 3
	Headset Tone	Selects whether a tone is heard from the attached headset while receiving a call.	<input type="checkbox"/> On <input type="checkbox"/> Off	Off
	Vibrate	Selects whether the handset vibrates while receiving a call.	<input type="checkbox"/> Vib.& Ring <input type="checkbox"/> Vib.→ Ring <input type="checkbox"/> Off	Off
	Ring On Charger	Selects the ringing mode (On or Off) while a handset is set on the charger.*1	<input type="checkbox"/> On <input type="checkbox"/> Off	On
	Single Tone	Selects the ringer pattern for each type of call.	<input type="checkbox"/> Bell 1-6 <input type="checkbox"/> Melody 1-9	Bell 1
	Double Tone		Selects the LED pattern for each type of call.*2  <input type="checkbox"/> Red <input type="checkbox"/> Green <input type="checkbox"/> Orange <input type="checkbox"/> R→ G→ O	Single Tone: Red Double Tone/ Private Ring: Green Triple Tone: Orange S-Double Tone: R→ G→ O
	Triple Tone			
	S-Double Tone			
	Private Ring	Selects the vibrate pattern for each type of call.	<input type="checkbox"/> Single <input type="checkbox"/> Double <input type="checkbox"/> Triple <input type="checkbox"/> Short Double <input type="checkbox"/> Short Triple <input type="checkbox"/> Short Term <input type="checkbox"/> Continuous	Single
	Category 1-9			

\*1 When "Ring On Charger" is set to on but "Ringer Volume" is set to off, the handset rings at level 1.

\*2 The LED pattern does not change when a call is being monitored with the Call Monitor feature.

# Setting the Handset and Base Unit

Main Item	Sub Item	Description	Setting	Default
Talk Option	Speaker Volume	Adjusts the rear speaker volume.	Level 1-6	Level 3
	Receiver Volume	Adjusts the receiver volume.	Level 1-4	Level 2
	Headset Volume	Adjusts the headset speaker volume.	Level 1-4	Level 2
	Headset Mic Vol	Adjusts the headset microphone volume.	Level 1-4	Level 1
Answer Option	Any Key Answer	Answers a call by pressing any dialing key.* <sup>1</sup>	<input type="checkbox"/> On <input type="checkbox"/> Off	Off
	Quick Answer	Answers a call while charging by just lifting up a handset from the charger.	<input type="checkbox"/> On <input type="checkbox"/> Off	Off
Tone Option	Key Tone	Turns the key tone off or on.	<input type="checkbox"/> On <input type="checkbox"/> Off	On
	Range Alarm	Selects whether the range alarm tone rings or not.	<input type="checkbox"/> Talk <input type="checkbox"/> Idle <input type="checkbox"/> Talk & Idle <input type="checkbox"/> Off	Talk
Display Option	Language	Selects the display language.	<input type="checkbox"/> English <input type="checkbox"/> Español <input type="checkbox"/> FRANÇAIS	English
	Backlight	Turns on the backlight of the LCD and keypad.	<input type="checkbox"/> On* <sup>2</sup> <input type="checkbox"/> On & Receiving <input type="checkbox"/> Off	On

\*<sup>1</sup> This feature functions when receiving Paging or Voice Calls as well.

\*<sup>2</sup> On: The backlight of the LCD and keypad is turned on for about 5 seconds:  
 – from the moment a call is received.  
 – after operating the handset.



## ***Setting the Handset and Base Unit***

<b>Main Item</b>	<b>Sub Item</b>	<b>Description</b>	<b>Setting</b>	<b>Default</b>
Display Option	LCD Contrast	Adjusts the LCD contrast.	Level 1-5	Level 3
	Standby Display	Edits the name displayed on the LCD while in standby mode.	16 characters	Not stored
	Category Name	Edits the category name.	Category 1-9	Not stored
	F-Key Name	Edits the names of the flexible keys. (max. 12 characters)	12 characters × 12 flexible keys	Not stored
	Guidance	Selects whether the guidance display is shown or not in standby mode.	<input type="checkbox"/> On <input type="checkbox"/> Off	On
	Date&Time Form "PBX Type-Type 2 (KX-TA308)" only (See page 34.)	Selects the format for the date shown on the display in the Incoming Call Log.	<input type="checkbox"/> DD-MM 12H <input type="checkbox"/> DD-MM 24H <input type="checkbox"/> MM-DD 12H <input type="checkbox"/> MM-DD 24H	DD-MM 12H
Other Option	Change Password	Changes the handset password. (4 digits)	<input type="checkbox"/> Enter Old Password.+ <input type="checkbox"/> Enter New Password.+ <input type="checkbox"/> Verify New Password.	1234
	Outgoing Log	Selects whether to save an outgoing log or not.	Enter Password.+ <input type="checkbox"/> On <input type="checkbox"/> Off	Off
	Reset Handset	Returns the handset settings (except Registration) to the default settings.	<input type="checkbox"/> Enter Password.+ <input type="checkbox"/> Select menu(s).+ <input type="checkbox"/> Press "OK".	Not stored

# Setting the Handset and Base Unit

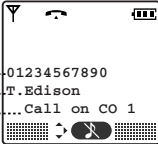
Main Item	Description	Setting	Default
<b>PBX Type</b>	Selects the type of PBX that the base unit is connected to.*1	<input type="checkbox"/> Type 1*2 <input type="checkbox"/> Type 2	Type 1
<b>Fwd/DND Icon</b>	When using a PBX other than a KX-TAW848/KX-TDA series PBX, you do not need to change this setting.	<input type="checkbox"/> Mode 1 <input type="checkbox"/> Mode 2	Mode 1
<b>Caller ID Line</b> “PBX Type-Type 1 (KX-TA624/824)” only	Selects which line of information is displayed as Caller ID. When the Caller ID matches an item stored in the Phonebook, the handset rings according to the setting of the item. As shown below, a caller’s number, caller’s name and CO line number are displayed on each line. Displayed items vary depending on your PBX and its settings.  <Example>  1st Line .....01234567890 2nd Line.....T. Edison 3rd Line .....Call on CO 1	<input type="checkbox"/> 1st Line <input type="checkbox"/> 2nd Line <input type="checkbox"/> 3rd Line	1st Line
<b>Date&amp;Time</b> “PBX Type-Type 2 (KX-TA308)” only	Sets the current date and time for the base unit.	Date Time	01-01-05 (D-M-Y) 12:00 AM (H:M)
<b>Incoming Log</b> “PBX Type-Type 2 (KX-TA308)” only	Sets each type of Incoming Call Log to either on or off.*3 You must set at least one of the incoming call types to on to store a received call in the Incoming Call Log.	Single Tone <input type="checkbox"/> On <input type="checkbox"/> Off Double Tone <input type="checkbox"/> On <input type="checkbox"/> Off Triple Tone <input type="checkbox"/> On <input type="checkbox"/> Off	Single Tone: Off Double Tone: Off Triple Tone: Off

\*1 After you set the PBX type, disconnect and reconnect the telephone cord.

\*2 To check the type of PBX you are using, see page 30.

\*3 When a check mark is displayed beside a tone type, the incoming call log for that tone type will be logged.







- These settings are only applied to your telephone, not the PBX itself.

# Troubleshooting and Error Messages

## ◆◆ Troubleshooting

Problem	Description and Solution
<p>The handset does not work.</p>	<ul style="list-style-type: none"> <li>• <b>The battery is drained.</b> → Charge the battery fully. (See “Charging the Battery” in the Installation Instructions.)</li> <li>• <b>The power is OFF.</b> → Turn it ON. (See “Handset” on page 3.) → Re-insert the battery and try again. (See “Battery Installation” in the Installation Instructions.)</li> </ul>
<p>The handset does not ring.</p>	<ul style="list-style-type: none"> <li>• <b>Ringer volume is set to “Off”.</b> → Adjust the ringer volume level. (See “Adjusting the Ringer Volume” on page 8.)</li> </ul>
<p>You cannot make/receive a call.</p>	<ul style="list-style-type: none"> <li>• <b>The handset is out of range or the telephone line is not connected properly.</b> → Move closer to the base unit. → Check the telephone line.</li> </ul>
<p>You cannot dial.</p>	<ul style="list-style-type: none"> <li>• <b>The number which you dialed is restricted by the PBX.</b> → Consult your dealer.</li> <li>• <b>The key lock mode is ON.</b> → To cancel the mode, press the Joystick for about 2 seconds. (See “Key Lock” on page 4.)</li> </ul>
<p>You cannot use the handset during a power failure.</p>	<ul style="list-style-type: none"> <li>• <b>The handset will not function during a power failure because the base unit stops emitting radiowaves.</b></li> </ul>
<p>You cannot have a conversation in hands-free mode.</p>	<p>→ Set program [617] Wireless PT Port Assignment to “Not Connect” in PBX System Programming.</p>
<p>The headset does not work.</p>	<ul style="list-style-type: none"> <li>• <b>A headset tone cannot be heard when receiving an incoming call, when the headset is attached.</b> → Make sure the headset tone setting is set to on. (See page 31.) → Make sure the headset jack is connected properly. (See “Handset” on page 3.)</li> </ul>
<p>The tone from the headset cannot be changed to a bell or melody.</p>	<ul style="list-style-type: none"> <li>• <b>The headset tone is a specific tone and is not related to the Incoming Option Tone settings (Single/Double/Triple/S-Double/Private Ring).</b></li> </ul>
<p>The date and time are not displayed correctly when viewing the Incoming Call Log.</p>	<p>→ Only for “PBX Type-Type 2 (KX-TA308)”: Set the correct date and time on the base unit. The form of the date and time can be set on the handset. (See “Setting the Date and Time” on page 6.) (See page 34.) → Only for “PBX Type-Type 1 (KX-TA624/824)”: Time settings can only be changed on the PBX.</p>

# Troubleshooting and Error Messages

Problem	Description and Solution
<p>While Caller ID is displayed using the Incoming Call Log, the display goes blank after pressing . (KX-TA624/824 only)</p>	<ul style="list-style-type: none"> <li>• <b>Caller ID is displayed for about 20 seconds. If you press  during that time period, the display goes blank until the time expires.</b> → Press  then press  to return to the standby display.</li> </ul>
<p>Some received calls are not stored in the Incoming Call Log. (KX-TA308 only)</p>	<ul style="list-style-type: none"> <li>→ Incoming calls via Voice Call/Paging/LCS/Auto Answer cannot be stored in the Incoming Call Log.</li> <li>→ Set at least one of the incoming call types to On. (See page 34.)</li> </ul>
<p>Some dialed calls are not stored in the Outgoing Call Log.</p>	<ul style="list-style-type: none"> <li>→ Outgoing calls using some PBX features (e.g., Redial, One-touch Dialing or Speed Dialing) cannot be stored in the Outgoing Call Log.</li> </ul>
<p>Even when in standby mode, you cannot access the Phonebook or other menus. ( is displayed in standby mode.)</p>	<ul style="list-style-type: none"> <li>• <b>The BGM setting may be on.</b> → KX-TA824: Set program [626] BGM Control for APT to “Disable” in PBX System Programming. → KX-TA308/624: Press “1” to turn BGM off.</li> </ul>
<p>Noise is frequently heard.</p>	<ul style="list-style-type: none"> <li>→ Set the handset and base unit away from other electrical appliances.</li> <li>→ Move closer to the base unit.</li> </ul>
<p>Two short beeps are heard during a conversation.</p>	<ul style="list-style-type: none"> <li>• <b>The radio signal is weak.</b> → Move closer to the base unit.</li> </ul>
<p>The charge indicator flashes red rapidly.</p>	<ul style="list-style-type: none"> <li>• <b>The charger is not connected properly.</b> → Make sure the battery is inserted properly. → Set the handset in the charger properly.</li> </ul>
<p>You charged the battery for 7 hours, but the beep tones sound every 5 seconds and  (needs to be charged) flashes after a few telephone calls.</p>	<ul style="list-style-type: none"> <li>• <b>The battery charge contacts may be dirty.</b> → Clean the battery charge contacts without damaging them and charge once more.</li> <li>• <b>It is time to change the battery.</b> → Replace with a new one.</li> </ul>
<p>The battery indicator does not display the remaining charge properly after you replace the battery.</p>	<ul style="list-style-type: none"> <li>→ Charge the battery for about 7 hours when the low battery warning is displayed.</li> </ul>
<p>While operating the unit, the AC adaptor feels warm. While charging the battery, the handset feels warm.</p>	<ul style="list-style-type: none"> <li>• <b>These are normal conditions.</b></li> </ul>

# Troubleshooting and Error Messages

## ◆◆ Error Messages

Displayed Message	Description and Solution
No Service	<ul style="list-style-type: none"><li>• <b>The handset is out of range.</b> → Move closer to the base unit.</li><li>• <b>The base unit is turned off.</b> → Make sure the power cord is connected.</li></ul>
Not Connected	<ul style="list-style-type: none"><li>• <b>The telephone cord between the PBX and the base unit is not connected.</b> → Make sure the telephone cord is connected.</li></ul>
Please Wait...	<ul style="list-style-type: none"><li>• <b>The handset is connecting to the base unit.</b> → Wait for a moment.</li></ul>
Charge Battery	<ul style="list-style-type: none"><li>• <b>The handset battery has little charge remaining.</b> → Charge the battery fully. (See “Charging the Battery” in the Installation Instructions.)</li></ul>
Memory Empty	<ul style="list-style-type: none"><li>• <b>When trying to view the Phonebook: No items have been stored.</b> (See “Storing an Item in the Handset Phonebook” on page 23.)</li><li>• <b>When trying to view the Incoming or Outgoing Call Log: No logs have been stored.</b></li></ul>
Memory Full	<ul style="list-style-type: none"><li>• <b>The Phonebook is full, and cannot store the new item.</b> → Remove unnecessary data in the Phonebook, and try again.</li></ul>
Over 24 Digits can't be stored.	<ul style="list-style-type: none"><li>• <b>You are trying to store a telephone number that is over 24 digits in the last free space in the Phonebook.</b> → Try to store the phone number as 24 digits or less, or remove unnecessary data in the Phonebook.</li></ul>
Need Repair 1(-2)	→ Consult your dealer.

# Important Information

## Battery Information

After your Panasonic battery is fully charged [at 25 °C (77 °F)]:

Operation	Operating Time
While in use (Talk)	Up to about 10 h
While not in use (Standby)	Up to about 250 h

- Operating time may be shortened depending on usage conditions and ambient temperature.
- The battery will drain slowly even while the unit is turned off.
- The handset can receive calls while charging.
- Battery consumption increases when the handset is used out of range. If “Y” flashes, power off the handset.

### ◆ Low Battery Warning

The battery needs to be charged in the following situations:

- “” flashes or the alarm sounds every 5 seconds.\*
- “Charge Battery” is displayed. In this situation, the handset cannot be operated.

\* If the low battery warning occurs during a conversation, the call will be disconnected automatically one minute later.

### ◆ Replacing the Battery

If “” flashes after using the phone for a short time, even when the battery has been fully charged, the battery should be replaced.

Before replacing the battery, make sure the low battery warning is displayed, then turn off the power to prevent memory loss. Replace the battery, and charge the new battery for at least 7 hours.

If you replace the battery before the low battery warnings appears, the battery strength icon may display an incorrect reading. In this case, use the handset as normal with the new battery installed. When the low battery warning is displayed, charge the battery for about 7 hours. The battery strength icon will then display the correct reading.

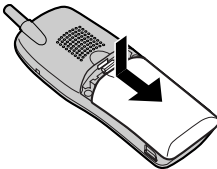

1. Turn the power off to prevent memory loss.
2. Press the notch on the cover firmly and slide it as indicated by the arrow.
3. Open the cover and replace the battery.
4. Close the cover and charge the handset.

- Please use a Panasonic battery with the service part number N4HHGMB00005 or HHR-P103.



This product is powered by a recyclable nickel-metal hydride battery.

Please call 1-800-8-BATTERY for information on how to recycle this battery.

There is a danger of explosion if the battery is incorrectly replaced.



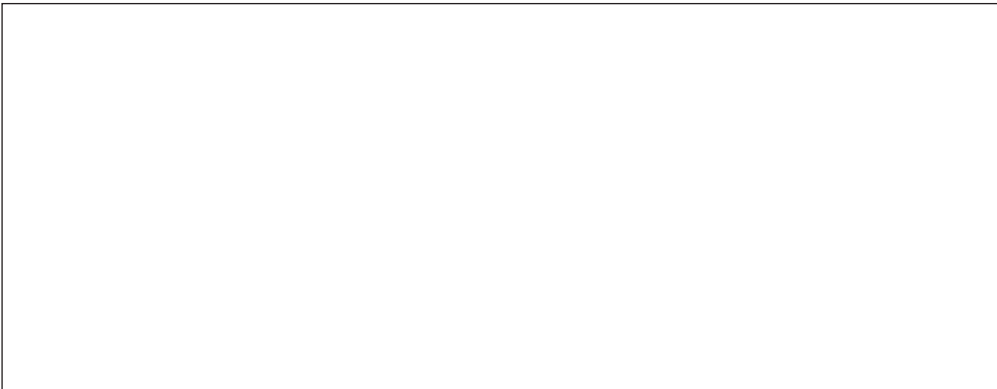

**Panasonic Consumer Electronics Company**  
**Division of Panasonic Corporation of**  
**North America**  
One Panasonic Way,  
Secaucus, New Jersey 07094  
<http://www.panasonic.com/csd>

**Panasonic Puerto Rico, Inc.**  
Ave. 65 de Infantería, Km. 9.5,  
San Gabriel Industrial Park, Carolina,  
Puerto Rico 00985

**Copyright:**

This material is copyrighted by Panasonic Communications Co., Ltd., and may be reproduced for internal use only. All other reproduction, in whole or in part, is prohibited without the written consent of Panasonic Communications Co., Ltd.

© 2005 Panasonic Communications Co., Ltd. All Rights Reserved.

**PSQX3737ZA** KK0905ST0